























5/2-directional valve, Series 740

- ATEX optional
- 5/2
- Qn = 700-950 l/min
- Pipe connection
- Compressed air connection output : Ø 8x1 Ø 10x1
- Electrical connection : Plug, EN 175301-803, form A
- Can be assembled into blocks
- Manual override : with detent
- double solenoid
- Pilot : Internal



Type	Diaphragm poppet valve
Activation	Electrically
Pilot	Internal
Sealing principle	Soft sealing
Blocking principle	Plate principle Single base plate principle
Working pressure min./max.	1,5 ... 10 bar
Ambient temperature min./max.	-15 ... 50 °C
Medium temperature min./max.	-15 ... 50 °C
Medium	Compressed air
Max. particle size	50 µm
Oil content of compressed air	0 ... 5 mg/m ³
Nominal flow Qn	See table below
Connector standard	EN 175301-803:2006
Protection class with connection	IP65
Reverse polarity protection	Protected against polarity reversal
Compatibility index	See table below
Duty cycle	100 %
Typ. switch-on time	40 ms
Mounting on manifold strip	PRS strip
Weight	See table below

Technical data

Part No.		MO	Compressed air connection	
			Input	Output
5727410220			Ø 8x1	Ø 8x1
5727410420			Ø 8x1	Ø 8x1
5727460220			Ø 10x1	Ø 10x1
5727460420			Ø 10x1	Ø 10x1
5727415280			Ø 8x1	Ø 8x1
5727440220			Ø 8x1	Ø 8x1
5727415480			Ø 8x1	Ø 8x1
5727465280			Ø 10x1	Ø 10x1
5727465480			Ø 10x1	Ø 10x1
5727415302			Ø 8x1	Ø 8x1
5727465302			Ø 10x1	Ø 10x1

Part No.	Compressed air connection	Operational voltage	
		DC	AC 50 Hz
	Exhaust		
5727410220	M14x1	24 V	-
5727410420	M14x1	24 V	-
5727460220	M14x1	24 V	-
5727460420	M14x1	24 V	-
5727415280	M14x1	-	230 V
5727440220	M14x1	24 V	-
5727415480	M14x1	-	230 V
5727465280	M14x1	-	230 V
5727465480	M14x1	-	230 V
5727415302	M14x1	-	-
5727465302	M14x1	-	-

Part No.	Operational voltage	Voltage tolerance		
		DC	AC 50 Hz	AC 60 Hz
	AC 60 Hz			
5727410220	-	-10% / +10%	-	-
5727410420	-	-10% / +10%	-	-
5727460220	-	-10% / +10%	-	-
5727460420	-	-10% / +10%	-	-
5727415280	230 V	-	-20% / +10%	-10% / +20%
5727440220	-	-10% / +10%	-	-
5727415480	230 V	-	-20% / +10%	-10% / +20%
5727465280	230 V	-	-20% / +10%	-10% / +20%
5727465480	230 V	-	-20% / +10%	-10% / +20%
5727415302	-	-	-	-
5727465302	-	-	-	-

Part No.	Power consumption		Holding power		Switch-on power
	DC	AC 50 Hz	AC 50 Hz	AC 60 Hz	AC 50 Hz
5727410220	2,1 W	-	-	-	-
5727410420	2,1 W	-	-	-	-
5727460220	2,1 W	-	-	-	-

Part No.	Power consumption	Holding power	Holding power	Switch-on power
	DC	AC 50 Hz	AC 60 Hz	AC 50 Hz
5727460420	2,1 W	-	-	-
5727415280	2,1 W	4,18 VA	3,3 VA	6,6 VA
5727440220	2,1 W	-	-	-
5727415480	2,1 W	4,18 VA	3,3 VA	6,6 VA
5727465280	2,1 W	4,18 VA	3,3 VA	6,6 VA
5727465480	2,1 W	4,18 VA	3,3 VA	6,6 VA
5727415302	-	-	-	-
5727465302	-	-	-	-

Part No.	Switch-on power	Nominal flow Qn	Compatibility index	Throttle
	AC 60 Hz			
5727410220	-	700 l/min	13 14	with throttle
5727410420	-	700 l/min	13 14	with throttle
5727460220	-	950 l/min	13 14	with throttle
5727460420	-	950 l/min	13 14	with throttle
5727415280	5,5 VA	700 l/min	14	with throttle
5727440220	-	700 l/min	13 14	with throttle
5727415480	5,5 VA	700 l/min	14	with throttle
5727465280	5,5 VA	950 l/min	14	with throttle
5727465480	5,5 VA	950 l/min	14	with throttle
5727415302	-	700 l/min	14	with throttle
5727465302	-	950 l/min	14	with throttle

Part No.	Valve plug connector	basic valve with electrical connector
5727410220	With valve plug connector	-
5727410420	Without valve plug connector	-
5727460220	With valve plug connector	-
5727460420	Without valve plug connector	-
5727415280	With valve plug connector	-
5727440220	With valve plug connector	-
5727415480	Without valve plug connector	-
5727465280	With valve plug connector	-
5727465480	Without valve plug connector	-
5727415302	-	Basic valve without coil
5727465302	-	Basic valve without coil

Part No.	Reverse polarity protection	ATEX	Weight	
5727410220	Protected against polarity reversal	-	0,555 kg	-
5727410420	Protected against polarity reversal	-	0,505 kg	-
5727460220	Protected against polarity reversal	-	0,555 kg	-
5727460420	Protected against polarity reversal	-	0,505 kg	-
5727415280	Protected against polarity reversal	-	0,544 kg	-
5727440220	Protected against polarity reversal	ATEX	-	1)
5727415480	Protected against polarity reversal	-	0,53 kg	-
5727465280	Protected against polarity reversal	-	0,539 kg	-
5727465480	Protected against polarity reversal	-	0,496 kg	-
5727415302	-	ATEX optional	0,319 kg	-

Part No.	Reverse polarity protection	ATEX	Weight	
5727465302	-	ATEX optional	0,316 kg	-

Nominal flow Qn at 6 bar and $\Delta p = 1$ bar, MO = Manual override

1) II 3G3D EEX nA IIB T4 IP65 T125 °C X

Technical information

The min. control pressure must be adhered to, since otherwise faulty switching and valve failure may result!

The pressure dew point must be at least 15 °C under ambient and medium temperature and may not exceed 3 °C .

The oil content of compressed air must remain constant during the life cycle.

Use only the approved oils from AVENTICS. Further information can be found in the "Technical information" document (available in the MediaCentre).

ATEX optional: ATEX version can be produced by combining the basic valve without coil with an ATEX coil. ATEX ID: see ATEX coils catalog page.

Technical information

Material	
Housing	Polyoxymethylene
Seals	Acrylonitrile butadiene rubber

Dimensions

Dimensions

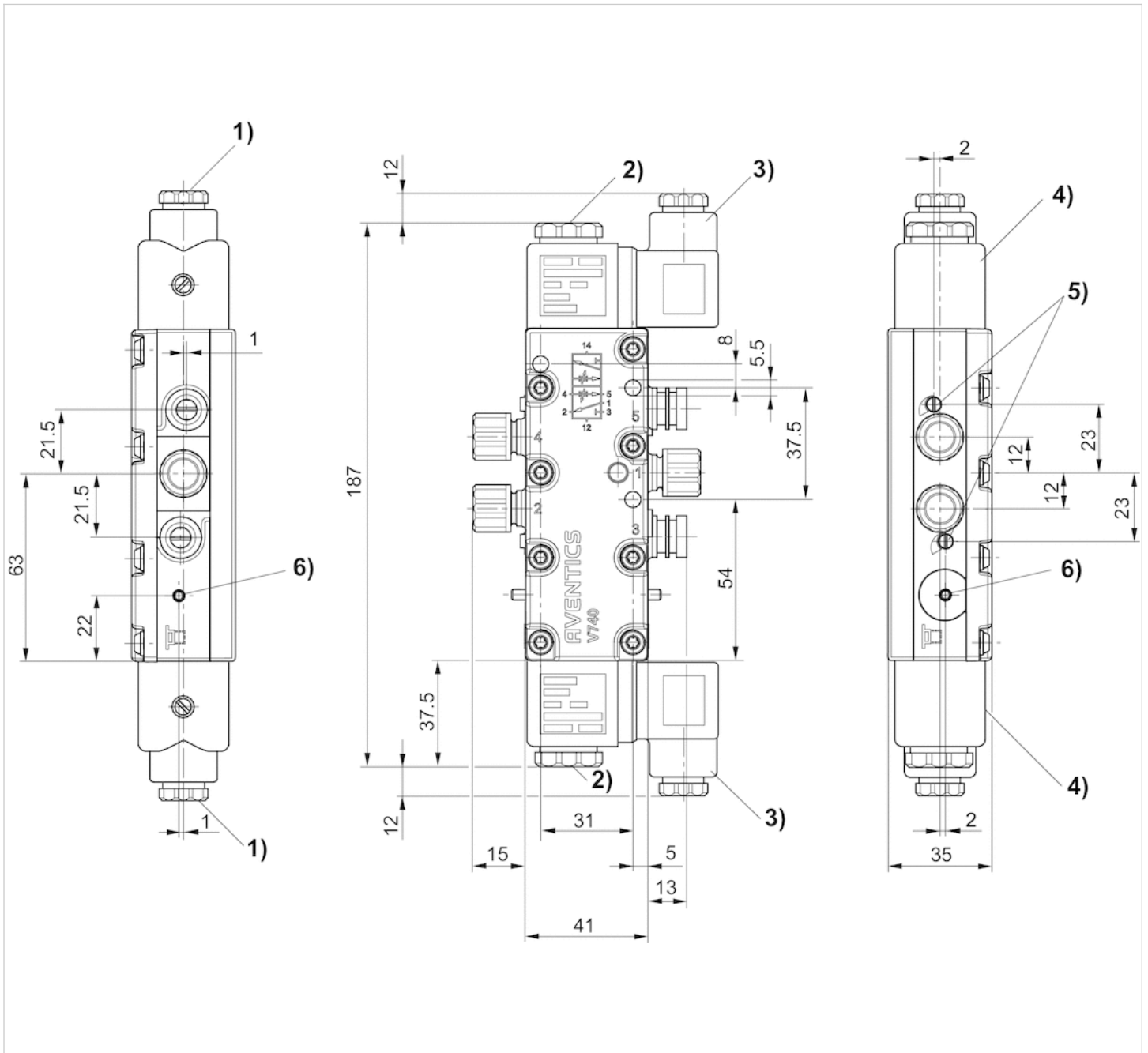

1) Gland fitting M16x1.52) M5 internal thread accessible under cap3) Valve plug connector can be rotated at 90° intervals4) Coil can be plugged at 45° intervals5) Flow control screw for exhausts 5 (R) and 3 (S)6) Manual override and position indicator

Efficient pneumatic solutions, our program: cylinders and drives, valves and valve systems, air supply management



Visit us: [Emerson.com/Aventics](https://www.emerson.com/Aventics)

Your local contact: [Emerson.com/contactus](https://www.emerson.com/contactus)



[Emerson.com](https://www.emerson.com)



[Facebook.com/EmersonAutomationSolutions](https://www.facebook.com/EmersonAutomationSolutions)



[LinkedIn.com/company/Emerson-Automation-Solutions](https://www.linkedin.com/company/Emerson-Automation-Solutions)



[Twitter.com/EMR_Automation](https://twitter.com/EMR_Automation)

An example configuration is depicted on the title page. The delivered product may thus vary from that in the illustration. Subject to change. This Document, as well as the data, specifications and other information set forth in it, are the exclusive property of AVENTICS GmbH. It may not be reproduced or given to third parties without its consent. Only use the AVENTICS products shown in industrial applications. Read the product documentation completely and carefully before using the product. Observe the applicable regulations and laws of the respective country. When integrating the product into applications, note the system manufacturer's specifications for safe use of the product. The data specified only serve to describe the product. No statements concerning a certain condition or suitability for a certain application can be derived from our information. The information given does not release the user from the obligation of own judgement and verification. It must be remembered that the products are subject to a natural process of wear and aging.

The Emerson logo is a trademark and service mark of Emerson Electric Co. Brand logotype are registered trademarks of one of the Emerson family of companies. All other marks are the property of their respective owners. © 2020 Emerson Electric Co. All rights reserved.
2020-12



CONSIDER IT SOLVED™